

Vejledning til 165.2

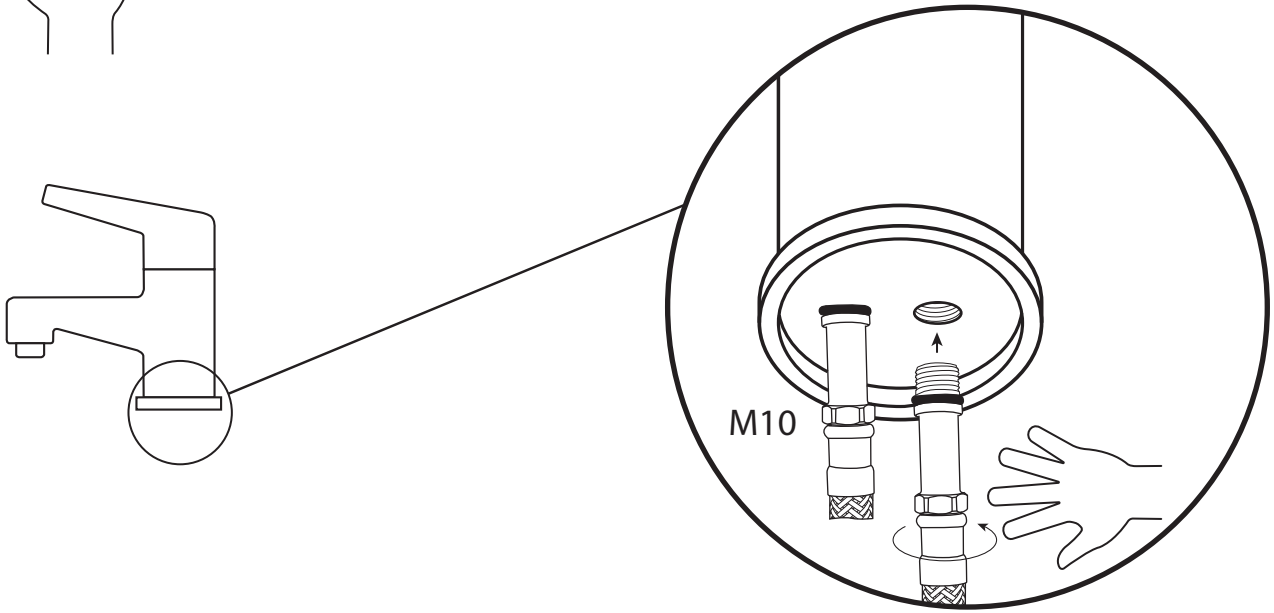

10 mm

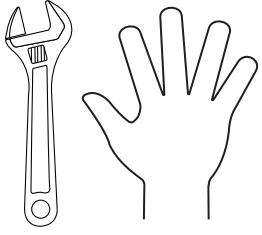
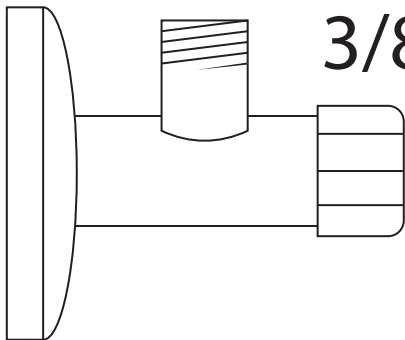
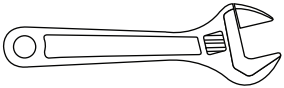
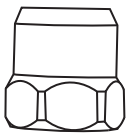

3/8"



10 mm

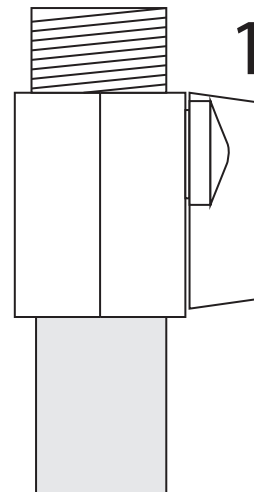
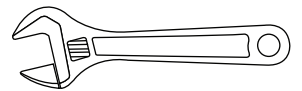
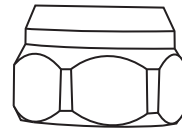

1/2"