

ADORA®

A07.00 DK
Brugsvejledning

Brusestangsæt



Anvendelse

- ADORA® brusestangsæt er produceret med henblik på at forsyne et brusebad med vand til personlig hygiejne
-

Garanti

- Der ydes 10 års garanti mod fabriktionsfejl. Garantien dækker reservedele
 - Købskvitteringen er produktets garantibevis. Opbevar købskvitteringen sammen med denne brugsvejledning
 - Det anbefales, at scanne eller kopiere kvitteringen, da tryksvæerte kan falme med tiden
-

Vedligeholdelse

- Overflader der er forkromede, farvede eller i rustfrit stål skal aftørres umiddelbart efter brug
 - Overflader udført i rustfrit stål skal jævnlgt overfladebehandles med plejeprodukter specielt til rustfrit stål
 - Rustfrit stål, der ikke vedligeholdes, risikerer at danne overfladerust
 - Håndbruserens dyser gnubbes dagligt, med hånden eller med et håndklæde
-

Rengøring

- Anvend kun neutrale rengøringsmidler, der ikke er slibende eller kalkopløsende, og ikke indeholder syre, klor, eller fosfor
- Ved brug af rengøringsmidler på spray, spray altid først på en klud og påfør derefter med kluden. Ved direkte spray på armaturet er der risiko for at beskadige gummiringe og andre vitale dele
- Anvend aldrig slibesvampe eller skuresvampe på armaturer
- Produkter udført i rustfrit stål skal jævnlgt rengøres med rengøringsmidler fremstillet specielt til rustfrit stål

Montering

ADORA® brusestangsæt monteres på en egnet væg i et egnet baderum. ADORA® brusestangsæt kan tilsluttes ethvert brusearmatur. Opstår der tvivl om korrekt installation, kontakt da en autoriseret VVS-installatør.

Installationens driftstryk skal være mellem 1 og 6 bar. Ved højere driftstryk skal der monteres tryk-reduktionsventiler på armaturet. Både på koldt- og varmtvandstilgang.

Hvis brusestangsættet ikke fungerer umiddelbart efter montering:

1. Lad brusestangsættet forblive monteret, og luk for vandtilførslen.
2. Se punktet 'Spørgsmål & Svar' i denne vejledning
3. For mere information se på www.adora-design.com eller skriv til: info@adora-design.com

Husk at vedhæfte foto af det installerede produkt, kopi af købskvittering og også evt. installationskvittering.

Før montering:

- Pak det nye brusestangsæt ud, og skab overblik over indholdet
- Kontroller at installation og væg passer til de medfølgende monteringsdele
- Hvis installation og væg ikke passer til de medfølgende monteringsdele, anskaf da yderligere monteringsdele hos forhandleren
- Kontroller at den koniske bruseholder vender rigtigt, med den brede del af den koniske brusereholder opad
- Klargør det nødvendige værktøj
- Afmonter det gamle brusesæt
- Observer at brusestangen monteres så tæt på armaturet, at den medfølgende bruseslange kan nå fra øverste position på stangen og ned til armaturet uden at slangen klemmer sammen.

Efter montering:

- Tilslut bruseslangens koniske omløber til håndbruseren og den anden til armaturet. Husk at lægge pakninger i omløberne på bruseslangen
- Kontroller at den koniske bruseholder glider uhindret
- Åbn langsomt for vandet på armaturet
- Kontroller at alle samlinger er tætte
- Gentag samme kontrol igen efter nogle timer for at sikre en succesfuld montering

Brusestangsæt med fleksibelt topbeslag

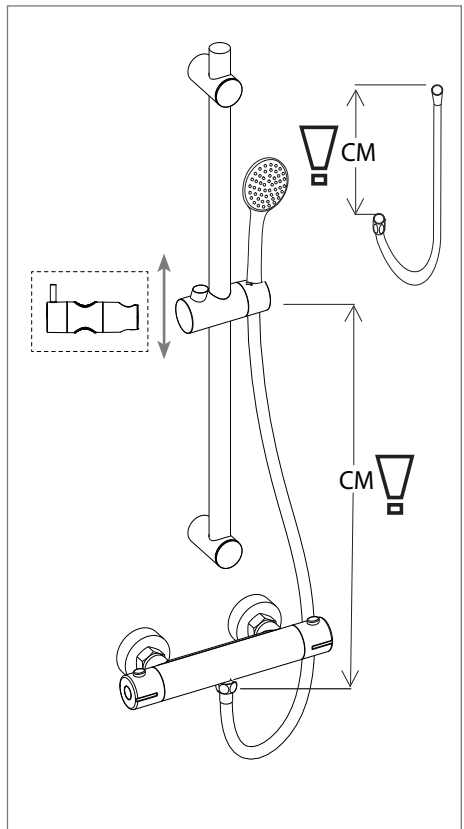
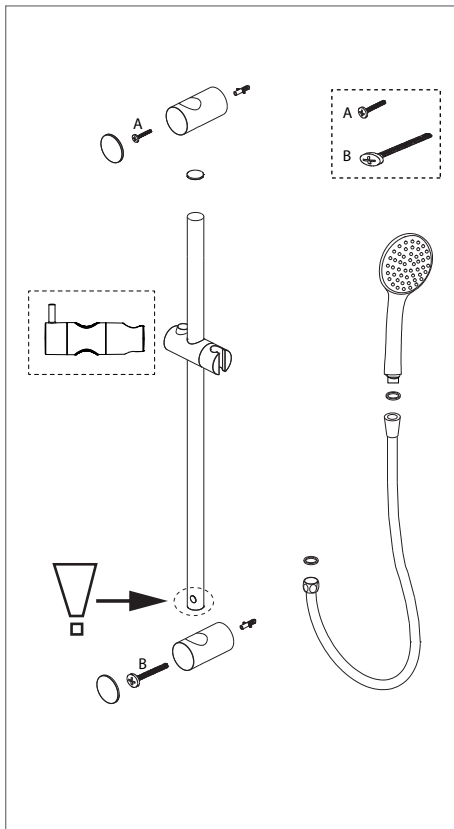
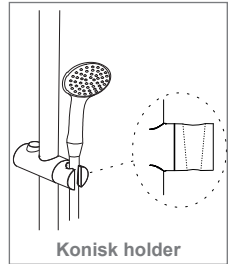
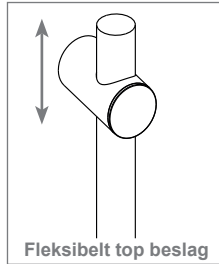
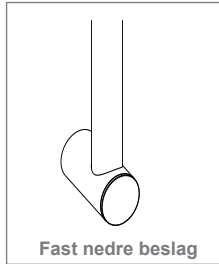
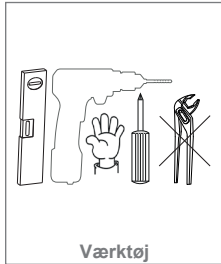

Brusestangsæt med faste beslag

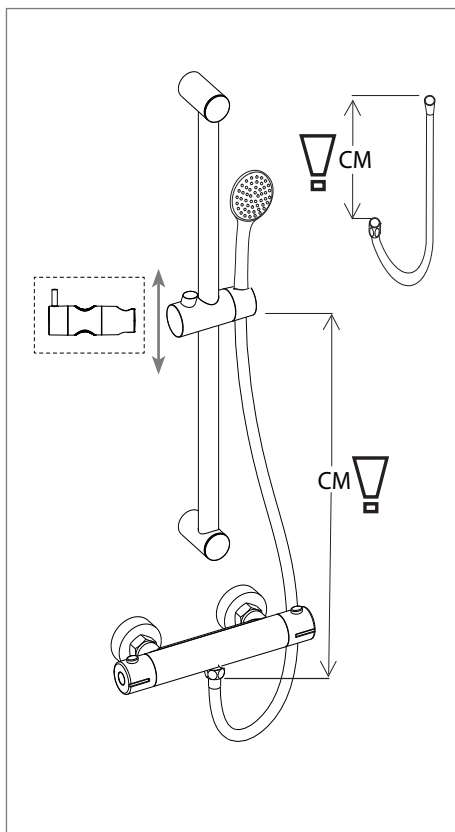
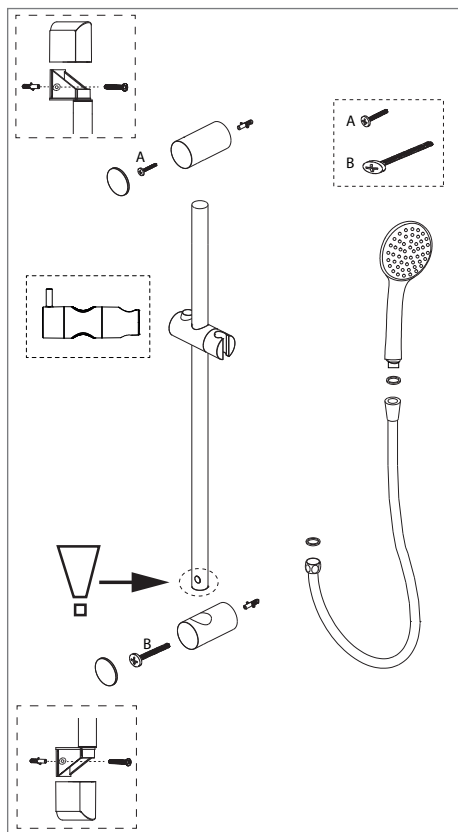
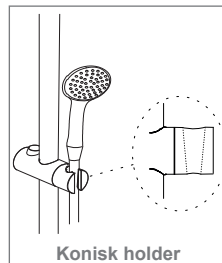
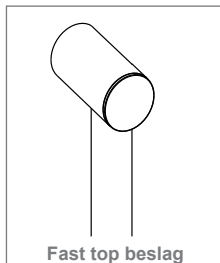
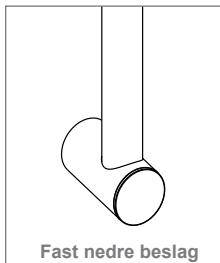
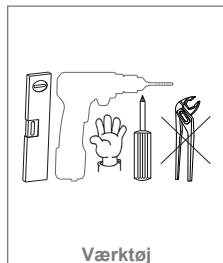

Spørgsmål & Svar

Skrueerne til beslag er ikke lige lange:

- Den korte skrue skal bruge til det øverste beslag
- Den lange skrue skal i det nederste beslag igennem hullet i stangen

Håndbruseren passer ikke i den koniske holder:

- Den forkerte ende af slangen er monteret på håndbruseren
- Den koniske holder vender forkert, drej den en halv omgang til korrekt position

Bruseslangen er for kort:

- Udskift til en længere slange

Der kommer for lidt vand ud:

Kontroller om:

- bruseslangen er klemt?
- håndbruseren har frit gennemløb?
- armaturet har et tilfredsstillende vandgennemløb?

Afkalk eller udskift. håndbruseren

Fjern en evt. vandspareindsats i håndbruseren.

Der kommer for meget vand ud:

- Skru ned for vandstrømmen på armaturet
- Monter evt. en vandsparer på armaturet

Håndbruseren drypper kortvarigt efter lukning af greb:

- Det er normalt. Det er det tilbageværende vand, der naturligt forlader brusehovedet

Der kommer mindre vand ud af håndbruseren:

- Afkalk eller udskift håndbruseren

Der drypper vand fra enden af bruseslangen:

- Kontroller at der er pakninger i omløberen

Vandspare

Vandspareeffekt er angivet ud fra et vandtryk på 3 bar, og er i forhold til brusere og armaturer uden nogen form for vandstrømsregulering. Vandspareeffekt er angivet for håndbruseren.

Reserve dele

Reserve delstegninger er tilgængelige på www.adora-design.com

Tekniske data

- Driftstryk: 1-6 bar
 - Maks vandtemperatur: 80 °C
-

Bortskaffelse

Gældende nationale regler om bortskaffelse og genanvendelse skal overholdes.

Ansvarsfraskrivelse

Forhandler, distributør og producent kan ikke gøres erstatningspligtig for:

- Fejl, mangler, skader og følgeskader opstået i forbindelse med fejlmontering
 - Skader på grund af kalk, frost og snavs fra vandforsyning
 - Manglende vedligeholdelse
 - Produktet monteret og anvendt uden at følge brugsvejledningen
 - Unødvendig voldsom behandling, der påfører produktet skade
-

Kontakt

www.adora-design.com - info@adora-design.com

ADORA®

A07.00 UK
User manual

Shower sets



Intanded use

- ADORA® shower set is manufactured to provide a shower with cold water, hot water and mixed water for personal hygiene
-

Guaranty

- A 10-year guaranty is granted against drip and manufacturing defects. The guaranty covers spare parts.
 - The purchase receipt is the product guaranty certificate. Keep the receipt together with the manual.
 - It is recommended to scan or copy the receipt, as printing ink may fade over time
-

Maintenance

- Surfaces with chromed or colored surfaces and faucets in stainless steel must be wiped immediately after use
 - Stainless steel surfaces must be treated frequently with care products made especially for stainless steel
 - Stainless steel, which is not properly maintained, is likely to grow surface rust
 - The shower nozzles are to be rubbed daily, by hand or with a towel
-

Cleaning

- Use only neutral detergents that are not abrasive or lime-soluble and do not contain acid, chlorine, or phosphorus
- When using sprayable detergents; always spray the detergent on a cloth first and then apply the cloth to the faucet. Direct spray on the faucet, gives a risk of damaging the rubber rings and other vital parts
- Never use abrasive vapors or scouring sponges on faucets
- Stainless steel products must be cleaned frequently with detergents made especially for stainless steel

Installation

ADORA® shower set shall be mounted on a suitable wall in a suitable bathroom. If there is any doubt about the correct installation, contact an authorized plumbing installer.

The operating pressure of the installation must be between 1 and 6 bar. At higher operating pressures, pressure reduction valves must be installed on the mixer. On both hot and cold-water connections.

If the shower set does not work immediately after installation:

1. Leave the faucet installed and shut off the water supply.
2. See the 'Questions & Answers' section in this manual.
3. For more information go to www.adora-design.com or write to: info@adora-design.com

Remember to attach some photos of the installed product. Furthermore, a copy of the purchase receipt and if possible, the installation receipt.

Before installation

- Unpack the new shower set and make yourself an overview of the content
- Make sure that the installation and the wall is compatible with the supplied mounting parts.
- If the installation and the wall does not fit together with the supplied mounting parts, obtain additional mounting parts at the dealer
- Remove the old shower set
- Observe that the shower rail is mounted close enough to the faucet to let the supplied shower hose reach all the way from the top position on the rail to the mixer without clamping the shower hose

After installation

- Connect the conical nut on the shower hose to the hand shower and the other nut to the mixer.
- Remember to place the gaskets in the nuts on the shower hose
- Check that the conical holder slides freely
- Slowly open the water on the mixer
- Check the hand shower functions, if any
- Check that all connections are tight, and not leaking
- Repeat the same check after a few hours to ensure successful mounting

Shower set with adjustable top bracket

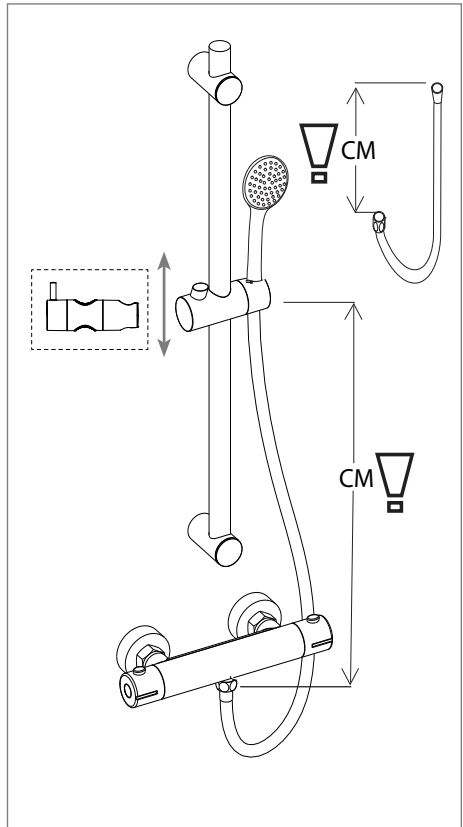
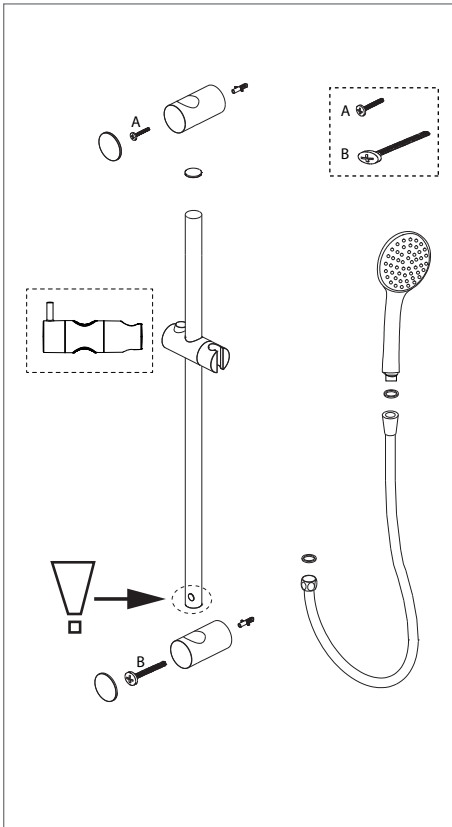
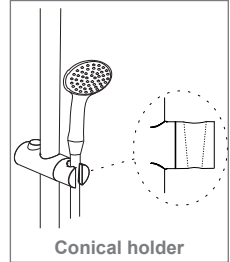
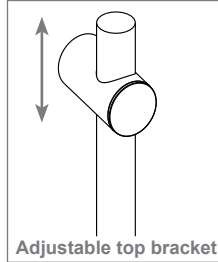
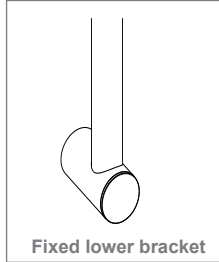

Shower set with fixed brackets

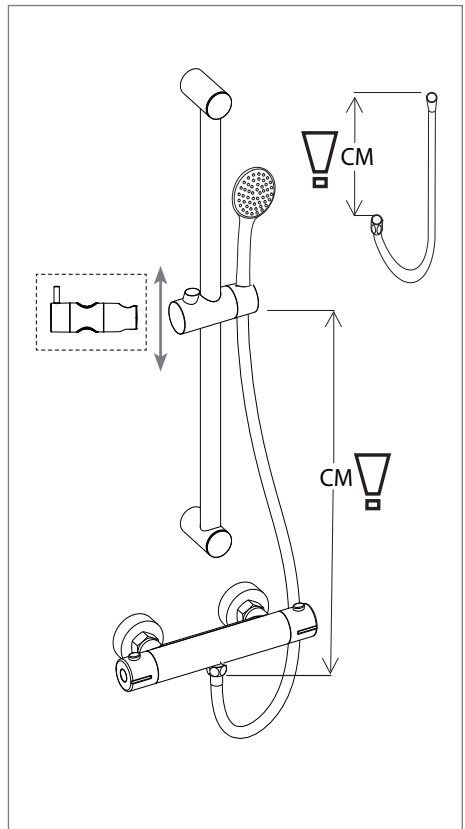
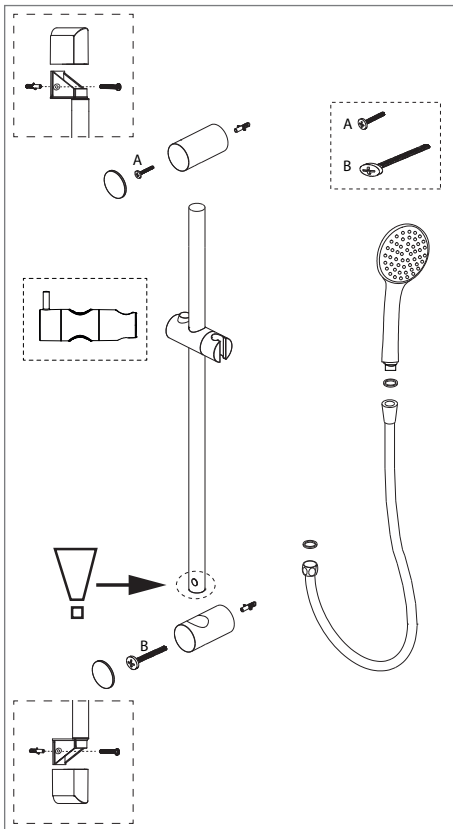
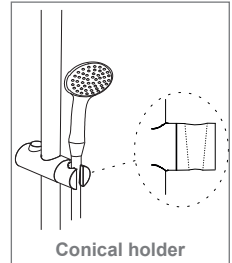
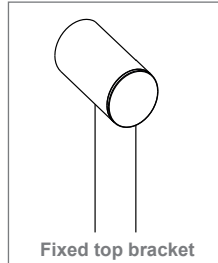
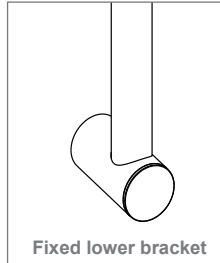
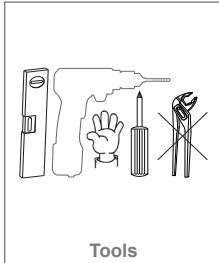

Questions & Answers

The screws for the brackets does not have the same length:

- The short screw is used for the top bracket
- The longer screw fits in the lower bracket through the hole in the rail

The hand shower does not fit into conical holder:

- The wrong side of the shower hose is connected to the hand shower
- The conical holder is in the wrong position, turn it 180 degrees into correct position

The shower hose is too short:

- Replace the shower hose to a longer one

Too little water comes out:

Check if:

- the hand shower hose is clamped?
- the hand shower has a free water flow?
- the mixer itself has a satisfactory water flow

Descale or replace the top shower and the hand shower
Remove the water restrictor in the hand shower, if any.

Too much water comes out:

- Turn down the water flow on the mixer
- If necessary, mount a water-saving device on the mixer

The hand shower drips briefly after closing handle:

- This is normal. The remaining water naturally leaves the shower head

Less water comes out of the hand shower:

- The hand shower is calcified
- Descale or replace the hand shower

Water drips from the end of the shower hose:

- Check if there are gaskets in the nuts on the shower hose

Water save

Water saving effect is indicated by a water pressure of 3 bar and is compared to showers and mixers without any water flow control.

Spare parts

Spare parts drawings are available at www.adora-design.com

Technical data

- Operating pressure: 1-6 bar
 - Max. inlet water temperature: 80 °C
-

Disposal

Local national regulations on disposal and recycling must be observed.

Disclaimer

Nor the dealer, distributor or manufacturer can be liable for:

- Faults, defects, damage and consequential damage caused by incorrect installation
 - Faults, defects, damage and consequential damage caused by incorrect use
 - Damage caused by limestone and frost damage
 - Damage due to dirt from the water supply
 - Lack of maintenance
 - Products installed and used without following the user manual
 - Unnecessary violent behavior that causes damage to the product
-

Contact

www.adora-design.com - info@adora-design.com

